

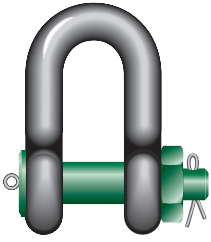

# Green Pin® Heavy Duty Shackles

## dee shackles with safety bolt



G-6038

- **Material** : bow and pin alloy steel, Grade 8, quenched and tempered
- **Safety Factor** : MBL equals 5 x WLL
- **Finish** : hot dipped galvanized
- **Certification** : 2.1 2.2 3.1 MTC<sup>a</sup> MPI<sup>a</sup> US<sup>a</sup> CE

working load limit	diameter bow	diameter pin	diameter eye	width eye	width inside	length inside	length	length bolt	thickness nut	weight each
t	a	b	c	d	e	f	g	h	i	kg
120	95	95	208	95	147	274	521	440	50	110

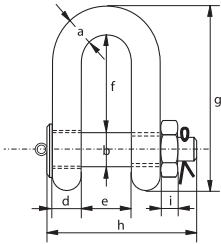

In inch

working load limit	diameter bow	diameter pin	diameter eye	width eye	width inside	length inside	length	length bolt	thickness nut	weight each
t	a	b	c	d	e	f	g	h	i	lbs
120	3 <sup>3</sup> / <sub>4</sub>	3 <sup>3</sup> / <sub>4</sub>	8 <sup>3</sup> / <sub>16</sub>	3 <sup>3</sup> / <sub>4</sub>	5 <sup>25</sup> / <sub>32</sub>	10 <sup>25</sup> / <sub>32</sub>	20 <sup>1</sup> / <sub>2</sub>	17 <sup>5</sup> / <sub>16</sub>	1 <sup>31</sup> / <sub>32</sub>	243

**RFID** **CAD**



## Applications

Shackles are used in lifting operations and static systems as removable links to connect (steel) wire rope, chain and other fittings. Screw pin shackles are used mainly for non-permanent applications. Safety bolt shackles are used for long-term or permanent applications or where the load may slide on the pin causing rotation of the pin.

Chain- or dee shackles are mainly used on one-leg systems whereas anchor- or bow shackles are mainly used on multi-leg systems.

## Range

Van Beest offers a wide range of bow and dee shackles for a wide variety of applications. The range stretches from WLL 0.33 t to 1550 t. This provides our customers with a very extensive range to choose a shackle that suits their application best. Most of the shackles are directly available from stock. Furthermore, shackles can be supplied to many standards such as the US Federal Specification RR-C-271, EN 13889, British Standard 3032, DIN 82101, DIN 82016 etc. Additionally we offer a wide range of general commercial shackles, which are not suitable for lifting but merely for fixing purposes.

## Design

All Van Beest shackles have a specific design for a specific application.

Some examples are:

- Green Pin® Super shackles which are made out of grade 8 steel. They are designed to be used in confined spaces. The higher material strength is used to reduce the physical dimensions of the product whilst maintaining its WLL and functionality of the product;
- Green Pin® Polar shackles are for use in extreme climatic conditions with material properties guaranteed up to temperatures of -40°C;
- Green Pin® Sling shackles are designed to provide a better radius to the sling it lifts. A bigger radius increases the life span of the sling significantly;
- Another example of functional design is a shackle pin with a square sunken hole. Because of the flat head there is less risk of the shackle getting caught in a net or a line.

These are all examples of highly functional designs, to optimize the use of the Van Beest shackles in daily use.

Shackles used for lifting applications are generally marked with:

- Working Load Limit ■ e.g. WLL 25 T
- manufacturer's symbol ■ e.g. GP
- traceability code ■ e.g. HA indicating a particular batch
- steel grade ■ e.g. 4, 6, 8
- CE conformity code (Conformité Européenne) ■ CE

Van Beest Green Pin® shackles meet all relevant requirements of the Machinery Directive 2006/42/EC and its latest amendments.

## Finish

Shackles supplied by Van Beest can be hot dipped galvanized, electro-galvanized, painted or self coloured, depending on the type of shackle and its application.

You can find the finish of each type of shackle in the product section further on.

## Certification

Upon request at time of order, all load rated shackles can be supplied with any of the following documents or certificates:

Free of Charge:

2.1 2.2 3.1 MTC<sup>a</sup> DNV 2.7-1<sup>a</sup> DNV 2.7-1<sup>b</sup> DNV 2.22 CE

With additional Charges:

MTC<sup>b</sup> MPI<sup>a</sup> MPI<sup>b</sup> US<sup>a</sup> US<sup>b</sup> BL

On request the proof load test certificates can be supplied surveyed by an official classification society, such as LROS, DNV GL, BV, ABS or any other officially certified inspection body.

Please verify your certification requirements with Van Beest at time of order.

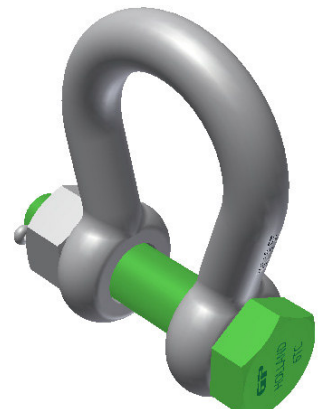



Green Pin® standard shackles and Green Pin® Polar shackles are DNV type approved. These shackles carry two DNV type approval certificates that show compliance with:

- DNV 2.7-1 Offshore Containers
- EN 12079-2 Offshore containers and associated lifting sets
- EN 13889 Forged steel shackles for general lifting purposes
- IMO/MSC Circular 860
- US Federal Specification RR-C-271
- DNV Standard for Certification No. 2.7-3 Portable Offshore Units
- DNV Standard for Certification No. 2.22 Lifting Appliances

The certificates S-7593 and S-7925 confirm that Green Pin® standard shackles and Green Pin® Polar shackles meet the requirements set in the latest version of the above mentioned DNV standards.

## Testing

Generally load rated products are Proofload tested, and certificates can be supplied upon request. For specific information on certificates we refer to the separate paragraph on certification.

Green Pin® shackles are Proofload tested at the following loads:

working load limit	Green Pin® standard shackles polar shackles heavy duty shackles	Green Pin® super shackles	Green Pin® sling shackles
	proof load	proof load	proof load
t	t	t	t
0.33	0.66		
0.5	1		
0.75	1.5		
1	2		
1.5	3		
2	4		
3.25	6.5		
3.3		6.6	
4.75	9.5		
5		10	
6.5	13		
7		14	14
8.5	17		
9.5	19	19	
12	24		
12.5		25	25
13.5	27		
15		30	
17	34		
18		36	36
21		42	
25	50		
30		60	60
35	70		
40		80	80
42.5	85		
55	110	110	110
75			112.5
85	170	170	
120	180	240	
125			187.5
150	225	225	225
175		262.5	
200	300		300
250	375		375
300	450		450
400	600		532
500	750		665
600	900		798
700	1050		931
800	1200		1064
900	1350		1197
1000	1500		1330
1250	1875		1663
1500	2250		
1550			2061.5

1  
2  
3  
4  
5  
6  
7  
8  
9  
10  
11  
12  
13  
14  
15  
16  
17  
18  
19  
20

## Instructions for use

Select the correct type and WLL of shackle and WLL for the particular application. If extreme circumstances or shock loading may occur, this must be well taken into account when selecting the correct shackle. Please note that commercial shackles are not to be used for lifting applications.

Shackles should be inspected before use to ensure that:

- all markings are legible;
- the body and pin are both of the same brand and type;
- the body and pin are both of the correct size;
- never use a safety bolt type shackle without using a securing pin;
- the pin, nut, cotter pin, or any other locking system cannot vibrate out of position;
- the threads of the pin and the body are undamaged;
- the body and the pin are not distorted or unduly worn;
- the body and pin are free from nicks, gouges, cracks and corrosion;
- shackles may not be heat treated as this may affect their WLL;
- never modify, repair or reshape a shackle by machining, welding, heating or bending as this will affect the WLL.

## Assembly

Ensure that the pin is correctly screwed into the shackle eye: tighten it hand-tight, then secure it using a wrench or other suitable tool so that the collar of the pin is fully seated against the shackle eye. Ensure that the pin is of the correct length so that it penetrates the full depth of the threaded eye and the collar of the pin seats against the surface of the shackle eye.

Incorrect seating of the pin may be caused by a bent pin, too tight fitting thread or misalignment of the pin holes. Do not use the shackle under these circumstances. Never replace a shackle pin except with one of the same brand, type, make and size to ensure the shackle maintains its original WLL.

Make sure that the shackle is supporting the load correctly, i.e. along the axis of the shackle body centerline. Avoid bending loads, unstable loads and overloads.

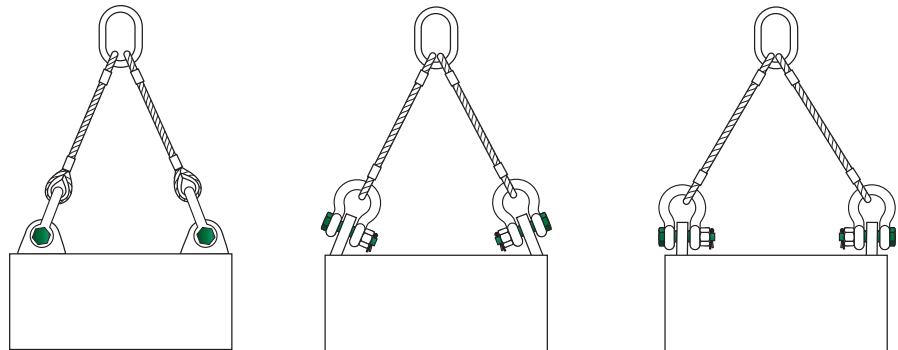

ONLY WITH REDUCED WLL

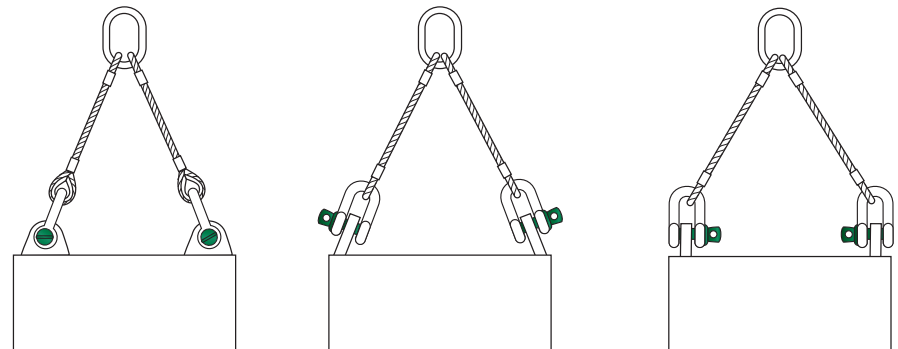

ONLY WITH REDUCED WLL

## Side loads

Side loads should be avoided, as the products are not designed for this purpose. If side loads cannot be avoided, the WLL of the shackle must be reduced:

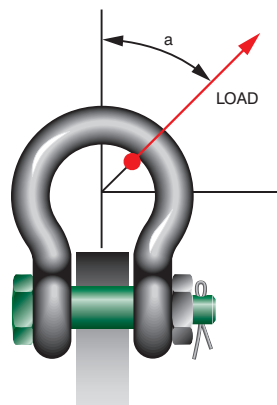
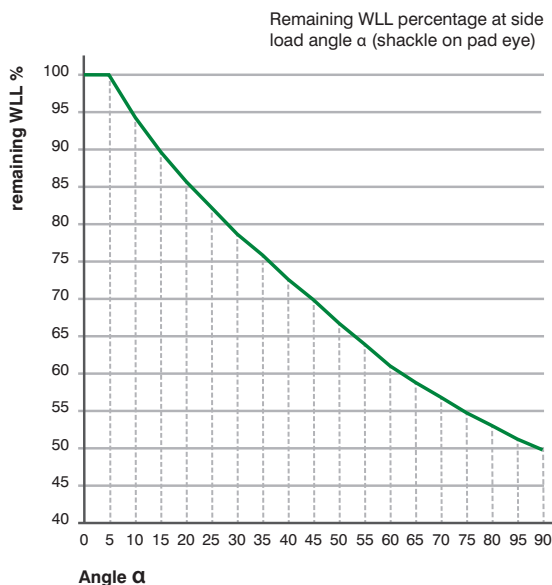

This graph is valid for all Green Pin® shackles, except P-6033 (Sling shackles). If you want to apply a side load on a Green Pin® Sling shackle, please contact Van Beest.

In-line lifting is considered to be a load perpendicular to the pin and in the plane of the bow. The load angles in the graph represent the deviating angles from in-line loading.

When connecting shackles to multi-leg slings, consider the effect of the angle between the legs of the sling. As the angle increases, so does the load in the sling leg and consequently in any shackle attached to that leg.

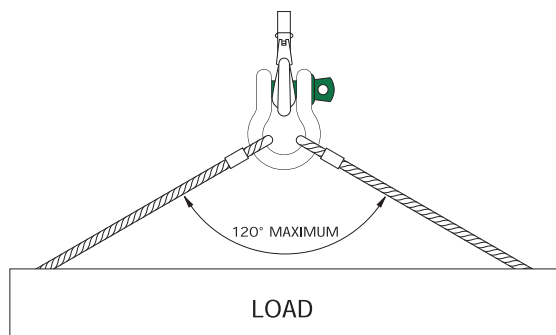

When a shackle is used to connect two slings to the hook of a lifting device, a bow type shackle must be used. The slings must be connected to the shackle body, and the shackle pin must be placed in the hook. The angle between the slings should not exceed 120°. If symmetrically loaded the shackle may be used to the full WLL.

To avoid eccentric loading of the shackle a loose spacer may be used on either end of the shackle pin. Do not reduce the width between the shackle jaws by welding washers or spacers to the inside of the shackle eyes or by narrowing the jaws, as this will affect the WLL of the shackle.

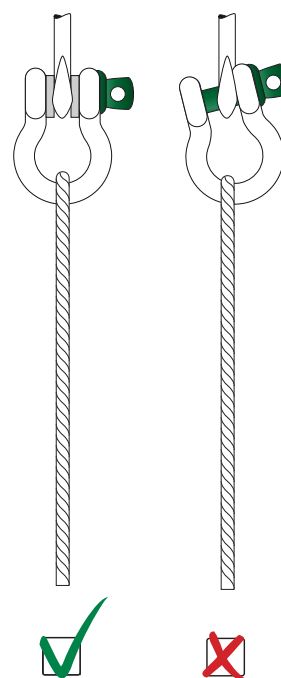

1

2

3

4

5

6

7

8

9

10

11

12

13

14

15

16

17

18

19

20

When a shackle is attached to the top block of a set of wire rope blocks the load on this shackle is increased by the value of the hoisting effect.

Avoid applications where the load moves over the shackle pin; the pin may rotate and possibly be unscrewed. If moving of the load cannot be avoided, or when the shackle is to be left in place for a prolonged period or where maximum pin security is required, use a shackle with a safety bolt, nut and cotter pin.

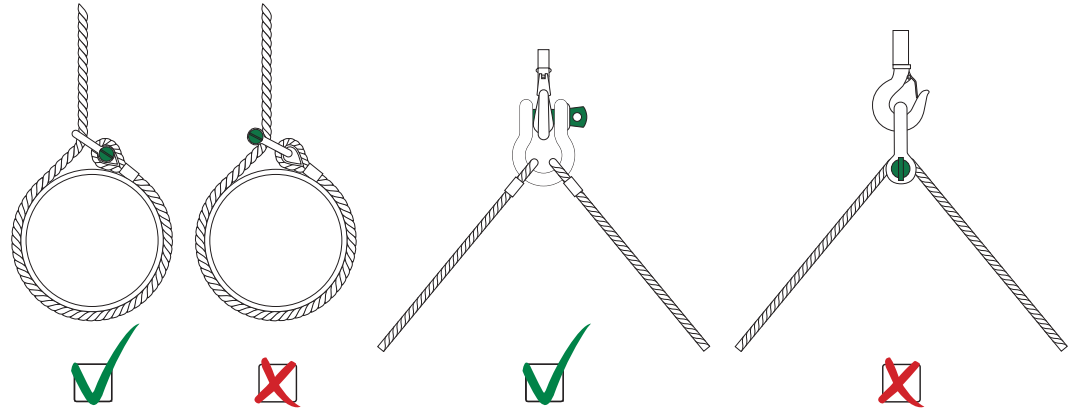

Shackles should not be immersed in acidic solutions or exposed to acidic fumes or other chemicals that are potentially harmful for the shackle.

## Point loading

Shackles are used in lifting- and static systems as removable links to connect (steel) wire rope, chain and other fittings. Most of the times the load bearing component that connects to a shackle is of a rounded shape. Point loading of shackles during lifting operations is allowed but the minimum dimension of the rounded component to be lifted should be equal to or bigger than the bow size of the shackle being used. The maximum load of the configuration is limited by the component with the lowest WLL.

Increasing the contact area by using bigger diameters and/or pad eyes can be an advantage. Sharp edges should be avoided.

Green Pin® shackles can also be used in below configurations. The maximum load of the configuration is limited by the component with the lowest WLL.

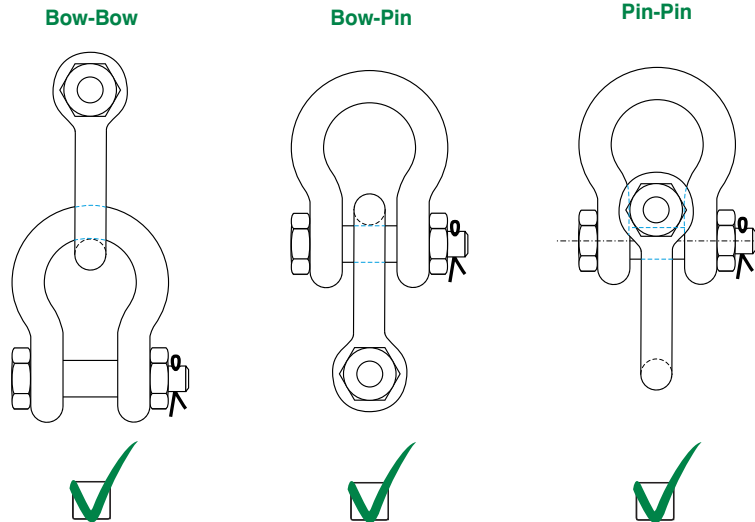

The crown of a Green Pin® Sling shackle is wider than that of a standard shackle, thus creating a bigger bearing surface. This improves the lifetime of the sling. Green Pin® Sling shackles can also be used in bellow configurations. The maximum load of the configuration is limited by the component with the lowest WLL.

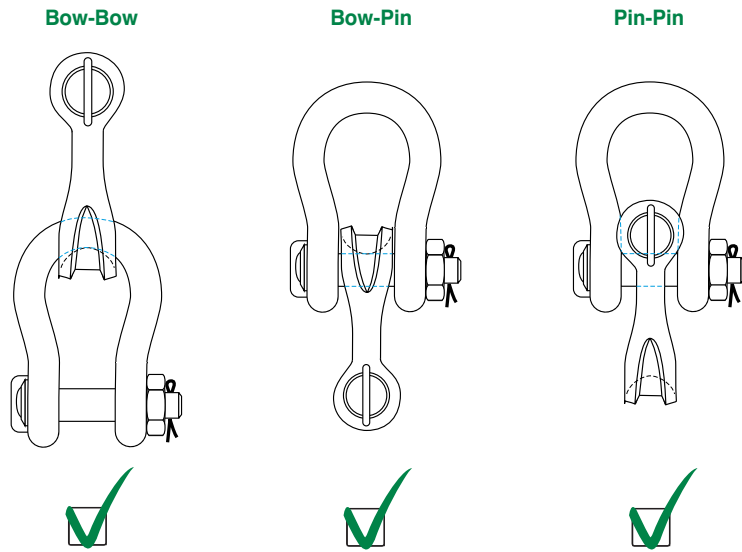

**Pin- Pin configuration:**

When the shackle eyes touch and the pins do not bear properly, the configuration should not be used.

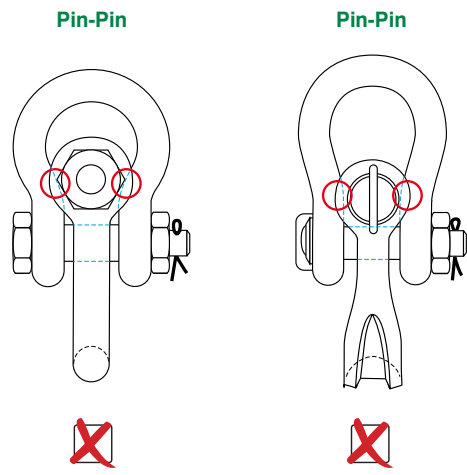

**Bow- Pin configuration:**

When the shackle body of the inner shackle touches the shackle eyes of the outer shackle and body and pin do not bear properly, the configuration should not be used.

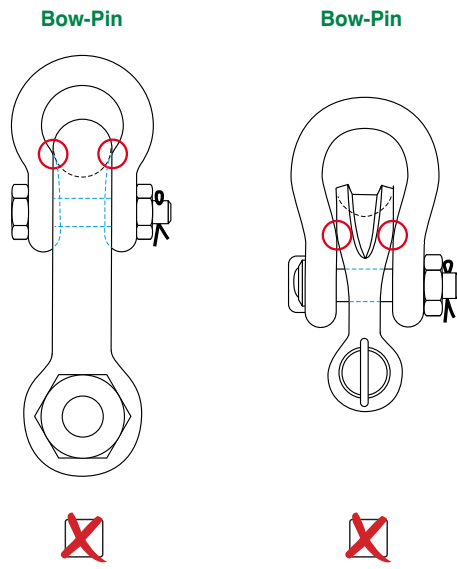

- 1
- 2
- 3
- 4
- 5
- 6
- 7
- 8
- 9
- 10
- 11
- 12
- 13
- 14
- 15
- 16
- 17
- 18
- 19
- 20

## Temperature

---

If extreme temperature situations occur, the following load reductions must be taken into account:

Temperature	Reduction for elevated temperatures New Working Load Limit
up to 200°C	100% of original Working Load Limit
200 - 300°C	90% of original Working Load Limit
300 - 400°C	75% of original Working Load Limit
> 400°C	not allowed

The rating of shackles to EN 13889 assumes the absence of exceptionally hazardous conditions. Exceptionally hazardous conditions include offshore activities, the lifting of persons and the lifting of potentially dangerous loads such as molten metals, corrosive materials or fissile materials. In such cases a competent person should assess the degree of hazard and the WLL should be reduced accordingly.

## Inspection

---

Shackles must be regularly inspected in accordance with the safety standards given in the country of use. This is required because the products in use may be affected by wear, misuse, overloading etc. which may lead to deformation and alteration of the material structure.

Inspection should take place at least every six months and more frequently when the shackles are used in severe operating conditions.